

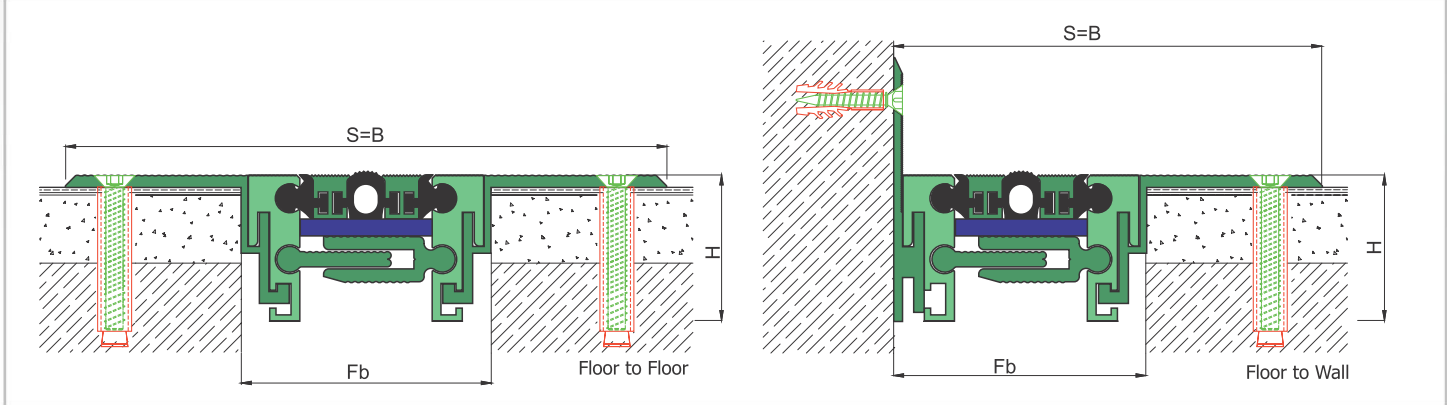

AS U236 surface mounted floor profiles can easily be applied to all types of floors and load bearing capacity is designed for heavy vehicles, cars or pedestrians depending on the gap required. Adjustable interlocking profile and gasket configuration makes it available for gaps up to 200 mm and enables to meet displacements in 3 directions. If required, AS U236 can be applied with wall type AS U136 and this dual application brings in a decorative aspect. Profiles are delivered factory-assembled.

- Application Areas** : Indoor & Outdoor / Floor
Ideal for : Factories, Warehouses, Car Parks, Shopping Malls, Airports, Residences, Hospitals, Hotels, Public & Commercial Buildings etc.
Material : Mill Finish Aluminum (Anodizing optional), TPE Gasket
Aluminum Alloy : 6063 AA-USA / EN AW 6063
Optional Supplies : Fire Barrier, Waterproof EPDM membrane

FLOOR

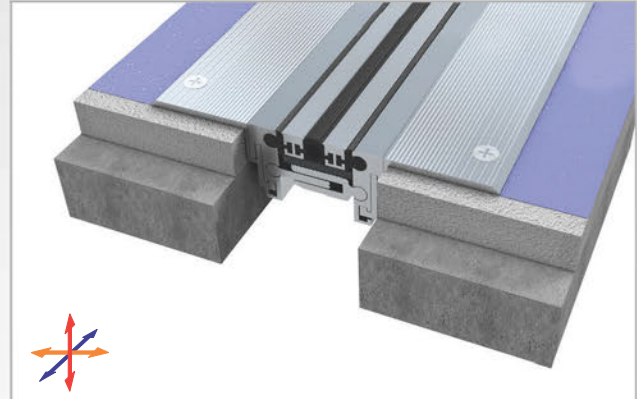
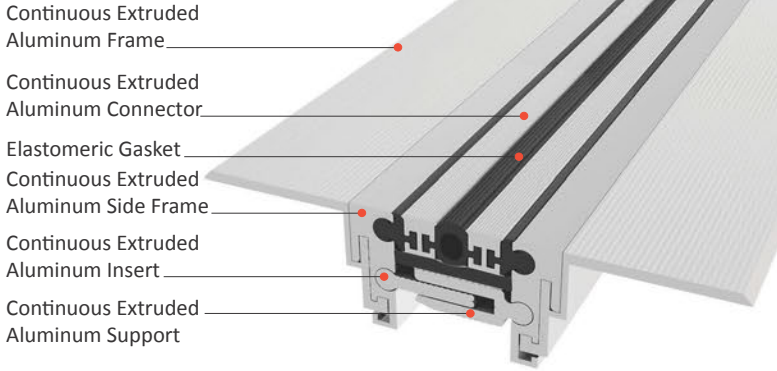

* Visuals are representative and the profile configuration may differ depending on the characteristics requested.

GASKET COLORS: **BLACK** GREY BEIGE Custom Colors available.

LOCATION	MODEL	GAP (Fb) mm	HEIGHT (H) MM	OVERALL WIDTH (B) mm	VISIBLE WIDTH (S) mm	MOVEMENT (W) mm	LOAD CAPACITY	STANDARD LENGTH (mt)
Floor to Floor	AS U236-050	50	43	154	154	± 2	70 kN 300 kN	3
	AS U236-080	80	43	178	178	± 4	25 kN 50 kN	3
	AS U236-100	100	43	204	204	± 6		3
	AS U236-120	120	43	224	224	± 8		3
	AS U236-140	140	43	244	244	± 10		3
	AS U236-160	160	43	264	264	± 12		3
	AS U236-180	180	43	284	284	± 14		3
	AS U236-200	200	43	304	304	± 14		3

Note: Please ask for different sizes



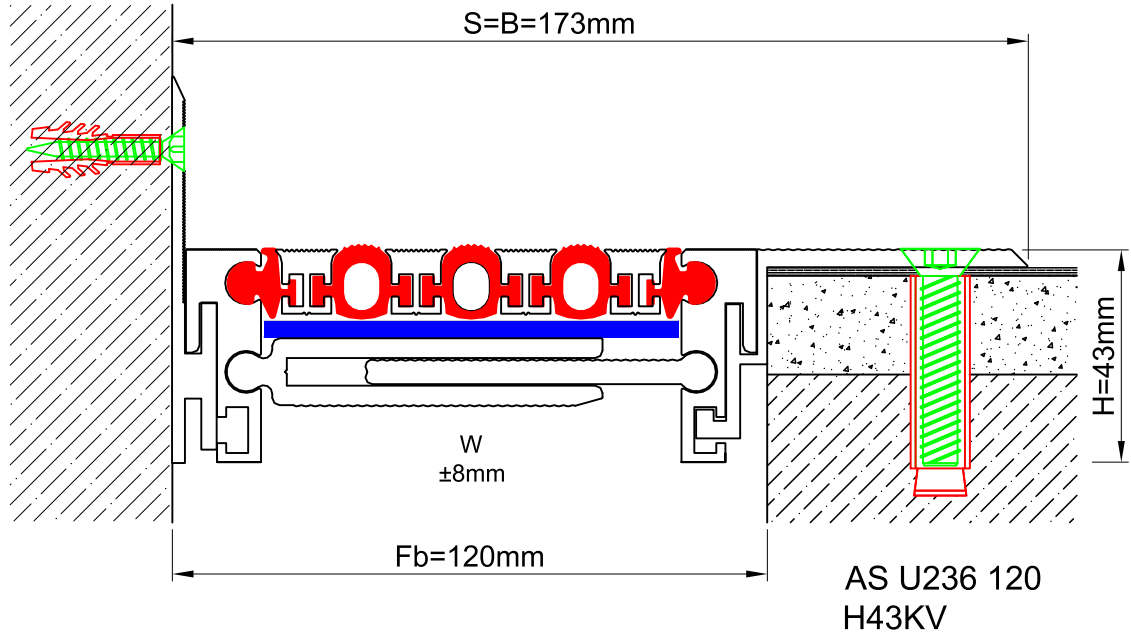
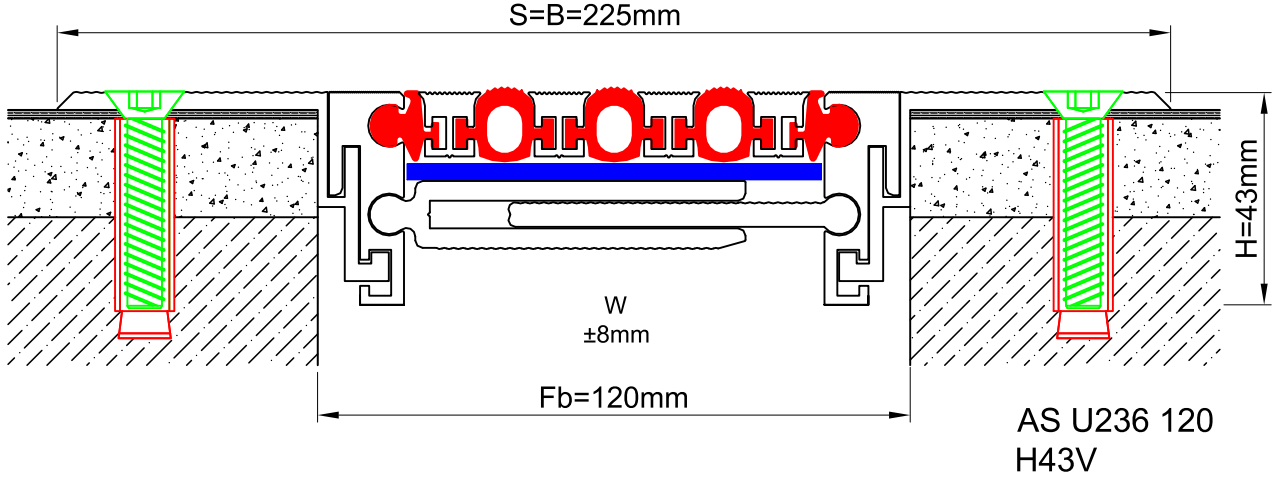

Profil No Profile Number	AS U236 120	AS U236 120K
Fb (mm)	120	120
H (mm) yaklaşık approx.	43	43
W± (mm) yaklaşık approx.	±8	±8
Renk Color	Alüminyum: Natürel, Fitiller: Siyah, gri, diğer Aluminum: Natural, Inserts: Black, grey, others	
Malzeme Material	Alüminyum, TPE Termoplastik Elastomer Aluminum, TPE Thermoplastic Elastomer	
Standart Uzunluk Standard Length	3	
Yükleme Kapasitesi Load-Bearing Capacity	